

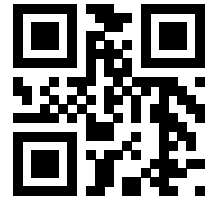

Technical Specification

90016601_1.0



Flygt 3127

50 Hz

Table of Contents

1 D-pump	2
1.1 Product description.....	2
1.2 Motor rating and performance curves.....	4
2 F-pump, Standard Motor	7
2.1 Product description 3127.182/.091.....	7
2.2 Product description 3127.350/.390.....	10
2.3 Motor rating and performance curves 3127.182/.091.....	12
2.4 Motor rating and performance curves 3127.350/.390.....	13
3 F-pump, Premium Efficiency Motor (IE3)	17
3.1 Product description.....	17
3.2 Motor rating and performance curves.....	19
4 M-pump	23
4.1 Product description.....	23
4.2 Motor rating and performance curves.....	25
5 N-pump, Standard Motor	27
5.1 Product description.....	27
5.2 Motor rating and performance curves.....	30
6 N-pump, Premium Efficiency Motor (IE3)	37
6.1 Product description.....	37
6.2 Motor rating and performance curves.....	40
7 Dimensions and Weight	44
7.1 Drawings.....	44

1 D-pump

1.1 Product description



Usage

A submersible pump, with vortex hydraulic, for liquids containing solids and abrasive media, or light wastewater.

Denomination

Type	Non-explosion proof version	Explosion proof version	Pressure class	Installation types
Gray iron	3127.182	3127.091	<ul style="list-style-type: none"> • MT – Medium head • HT – High head 	P, S, X

The pump can be used in the following installations:

- P Semipermanent, wet well arrangement with the pump installed on two guide bars. The connection to the discharge is automatic.
- S Portable semipermanent, wet well arrangement with hose coupling or flange for connection to the discharge pipeline.
- X Optional installation, wet or dry well arrangement without predetermined mechanical connection and with drilled flanges. Dry well arrangement requires cooling system or de-rated motor.

Application limits

Feature	Description
Liquid temperature	Maximum 40°C (104°F)
Liquid temperature, warm water version	Maximum 70°C (158°F)
Depth of immersion	Maximum 20 m (65 ft)
pH of the pumped liquid	5.5 - 14
Liquid density	Maximum 1100 kg/m ³

Motor data

Feature	Description
Motor type	Squirrel-cage induction motor
Frequency	50 Hz

Feature	Description
Power supply	3-phase
Starting method	<ul style="list-style-type: none"> • Direct on-line • Star-delta • Soft starter • Variable Frequency Drive (VFD)
Number of starts per hour	Maximum 30
Code compliance	IEC 60034-1
Voltage variation	<ul style="list-style-type: none"> • Continuously running: Maximum $\pm 5\%$ • Intermittent running: Maximum $\pm 10\%$
Voltage imbalance between phases	Maximum 2%
Stator insulation class	H (180°C, 356°F)

Motor encapsulation

Motor encapsulation is in accordance with IP68.

Cables

Application	Type
Direct-on-line start	Flygt SUBCAB® - a heavy duty 4 cores motor power cable with two twisted pair screened control cores. Conductor insulation rating of 90°C, which allows for increased current. Superior mechanical strength and high abrasion and tear resistant. Chemical resistant within pH 3-10 and ozone, oil, and flame resistant. Used up to 70°C water temperature. Cables < 10 mm ² with unscreened control cores.
Y/D start	Screened Flygt SUBCAB® - a heavy duty 4 screened cores motor power cable with four twisted pair screened control cores. Conductor insulation rating of 90°C, which allows for increased current. Superior mechanical strength and high abrasion and tear resistant. Chemical resistant within pH 3-10 and ozone, oil, and flame resistant. Used up to 70°C water temperature.
Variable Frequency drive	Screened Flygt SUBCAB® - a heavy duty 4 screened cores motor power cable with four twisted pair screened control cores. Conductor insulation rating of 90°C, which allows for increased current. Superior mechanical strength and high abrasion and tear resistant. Chemical resistant within pH 3-10 and ozone, oil, and flame resistant. Used up to 70°C water temperature.

Monitoring equipment

Thermal contacts opening temperature 125°C (257°F)

Materials

Table 1: Major parts except mechanical seals

Denomination	Material	ASTM	EN
Major castings	Cast iron, gray	35B	GJL-250
Pump housing, alternative 1	Cast iron, gray	35B	GJL-250
Pump housing, alternative 2	Cast iron, gray	35B	GJL-250
Impeller, alternative 1	Cast iron, gray	35B	GJL-250

Denomination	Material	ASTM	EN
Impeller, alternative 2	Cast iron, gray	35B	GJL-250
Impeller, alternative 3	Cast iron, gray	30B	GJL-200
Lifting handle	Stainless steel	AISI 316L	1.4404,1.4432, ...
Shaft	Stainless steel	AISI 431	1.4057+QT800
Screws and nuts	Stainless steel, A4	AISI 316L, 316, 316Ti	1.4401,1.4404, ...
O-rings, alternative 1	Nitrile rubber (NBR) 70° IRH	-	-
O-rings, alternative 2	Fluorinated rubber (FPM) 70° IRH	-	-
Oil, part no 901752	Medical white oil of paraffin type. Fulfills FDA 172.878 (a)	-	-

Table 2: Mechanical seals

Alternative	Inner seal	Outer seal
1	Corrosion resistant cemented carbide (WCCR)/ Aluminum oxide (Al ₂ O ₃)	Corrosion resistant cemented carbide (WCCR)/ Corrosion resistant cemented carbide (WCCR)
2	Corrosion resistant cemented carbide (WCCR)/ Corrosion resistant cemented carbide (WCCR)	Silicon carbide (RSiC)/ Silicon carbide (RSiC)
3	Corrosion resistant cemented carbide (WCCR)/ Corrosion resistant cemented carbide (WCCR)	Corrosion resistant cemented carbide (WCCR)/ Corrosion resistant cemented carbide (WCCR)

Surface treatment

Priming	Finish
Painted with a primer, see internal standard M0700.00.0002	Navy gray color NCS 5804-B07G. Two-component high-solid top coating, see internal standard M0700.00.0004 for standard painting and M0700.00.0008 for special painting.

Options

- Warm liquid version (non-explosion proof versions)
- Leakage sensor in the stator housing (FLS)
- Leakage sensor in the oil housing (CLS)
- Surface treatment (Epoxy)
- Zinc anodes
- Other cables

Accessories

Discharge connections, adapters, hose connections, and other mechanical accessories
Electrical accessories such as pump controller, control panels, starters, monitoring relays, cables

1.2 Motor rating and performance curves

These are examples of motor rating and curves. For more information, please contact your local sales and service representative.

Star-delta starting current is 1/3 of Direct on-line starting current.

MT

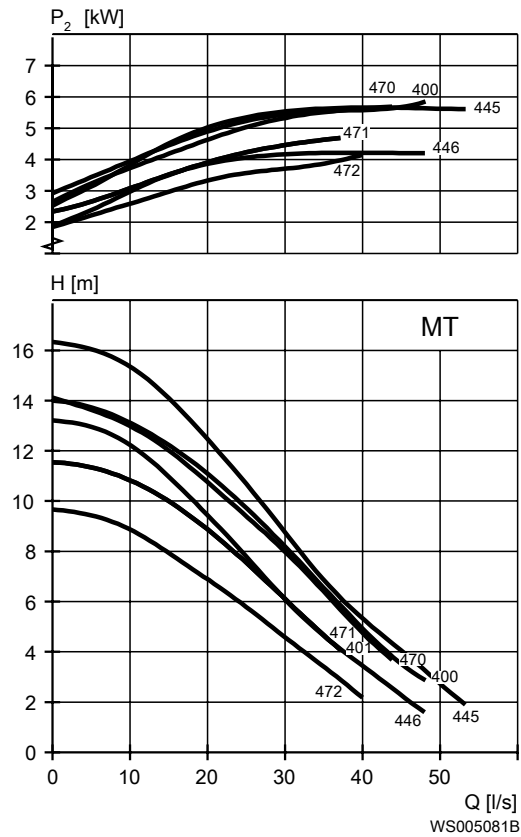

Table 3: 400 V, 50 Hz, 3-phase

Rated power, kW	Rated power, hp	Curve/Impeller No	Revolutions per minute, rpm	Rated current, A	Starting current, A	Power factor, $\cos \varphi$	Installation
4.7	6.3	401	1460	10	73	0.78	P
4.7	6.3	446	1460	10	73	0.78	P,S,X
4.7	6.3	471	1460	10	73	0.78	P,X
4.7	6.3	472	1460	10	73	0.78	P,X
5.9	7.9	400	1450	13	76	0.81	P
5.9	7.9	401	1450	13	76	0.81	P
5.9	7.9	445	1450	13	76	0.81	P,S,X
5.9	7.9	446	1450	13	76	0.81	P,S,X
5.9	7.9	470	1450	13	76	0.81	P,X
5.9	7.9	471	1450	13	76	0.81	P,X
5.9	7.9	472	1450	13	76	0.81	P,X

HT

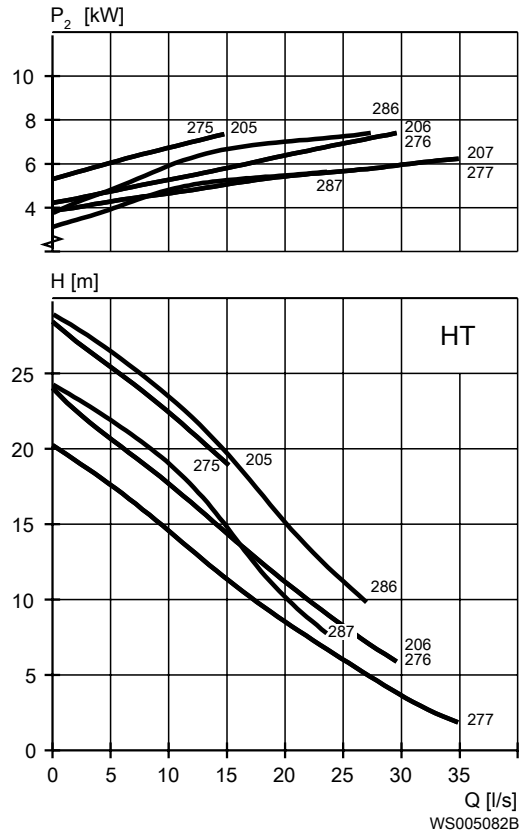

Table 4: 400 V, 50 Hz, 3-phase

Rated power, kW	Rated power, hp	Curve/Impeller No	Revolutions per minute, rpm	Rated current, A	Starting current, A	Power factor, $\cos \varphi$	Installation
7.4	9.9	205	2900	14	114	0.89	P,S,X
7.4	9.9	206	2900	14	114	0.89	P,S,X
7.4	9.9	207	2900	14	114	0.89	P,S,X
7.4	9.9	275	2900	14	114	0.89	P,S,X
7.4	9.9	276	2900	14	114	0.89	P,S,X
7.4	9.9	277	2900	14	114	0.89	P,S,X
7.4	9.9	286	2900	14	114	0.89	P,S,X
7.4	9.9	287	2900	14	114	0.89	P,S,X

2 F-pump, Standard Motor

2.1 Product description 3127.182/.091



Usage

A submersible pump for liquid manure, or heavily contaminated sewage and sludge. The impeller is S-shaped and has a cutting function. The pump is protected by a break pin.

Denomination

Type	Non-explosion proof version	Explosion proof version	Installation types	Installation types
Chopper Gray iron	3127.182	3127.091	• LT – Low head	J, P, S, X

The pump can be used in the following installations:

- J Semipermanent, wet well arrangement with guide bars or wire for a pump with a jet nozzle intended for mixing. For connection to a discharge stool. Jet nozzle can also be used as a hose connection.
- P Semipermanent, wet well arrangement with the pump installed on two guide bars. The connection to the discharge is automatic.
- S Portable semipermanent, wet well arrangement with hose coupling or flange for connection to the discharge pipeline.
- X Optional installation, wet or dry well arrangement without predetermined mechanical connection and with drilled flanges. Dry well arrangement requires cooling system or de-rated motor.

Application limits

Feature	Description
Liquid temperature	Maximum 40°C (104°F)
Liquid temperature, warm water version	Maximum 70°C (158°F)
Depth of immersion	Maximum 20 m (65 ft)
pH of the pumped liquid	5.5 - 14
Liquid density	Maximum 1100 kg/m ³

Motor data

Feature	Description
Motor type	Squirrel-cage induction motor
Frequency	50 Hz
Power supply	3-phase
Starting method	<ul style="list-style-type: none"> • Direct on-line • Star-delta • Soft starter • Variable Frequency Drive (VFD)
Number of starts per hour	Maximum 30
Code compliance	IEC 60034-1
Voltage variation	<ul style="list-style-type: none"> • Continuously running: Maximum $\pm 5\%$ • Intermittent running: Maximum $\pm 10\%$
Voltage imbalance between phases	Maximum 2%
Stator insulation class	H (180°C, 356°F)

Cables

Application	Type
Direct-on-line start	Flygt SUBCAB® - a heavy duty 4 cores motor power cable with two twisted pair screened control cores. Conductor insulation rating of 90°C, which allows for increased current. Superior mechanical strength and high abrasion and tear resistant. Chemical resistant within pH 3-10 and ozone, oil, and flame resistant. Used up to 70°C water temperature. Cables < 10 mm ² with unscreened control cores.
Y/D start	Flygt SUBCAB® - a heavy duty 7 cores motor power cable with two twisted pair screened control cores. Conductor insulation rating of 90°C, which allows for increased current. Superior mechanical strength and high abrasion and tear resistant. Chemical resistant within pH 3-10 and ozone, oil, and flame resistant. Used up to 70°C water temperature. Cables < 7G6 mm ² with unscreened control cores.
Variable Frequency drive	Screened Flygt SUBCAB® - a heavy duty 4 screened cores motor power cable with four twisted pair screened control cores. Conductor insulation rating of 90°C, which allows for increased current. Superior mechanical strength and high abrasion and tear resistant. Chemical resistant within pH 3-10 and ozone, oil, and flame resistant. Used up to 70°C water temperature.

Monitoring equipment

Thermal contacts opening temperature 125°C (257°F)

Materials

Table 5: Major parts except mechanical seals

Denomination	Material	ASTM	EN
Major castings	Cast iron, gray	35B	GJL-250
Pump housing	Cast iron, gray	35B	GJL-250
Impeller	Cast iron, nodular	-	GJS-400-18-LT

Denomination	Material	ASTM	EN
Suction cover, alternative 1	Cast iron, Hard-Iron™	A 532 IIIA	GJN-HB555(XCR23)
Suction cover, alternative 2	Steel	A 572 GR50	S355
Suction cover, alternative 3	Cast iron, Hard-Iron™	A 532 IIIA	GJN-HB555(XCR23)
Lifting handle	Stainless steel	AISI 316L	1.4404,1.4432, ...
Shaft	Stainless steel	AISI 431	1.4057+QT800
Screws and nuts	Stainless steel, A4	AISI 316L, 316, 316Ti	1.4401,1.4404, ...
O-rings, alternative 1	Nitrile rubber (NBR) 70° IRH	-	-
O-rings, alternative 2	Fluorinated rubber (FPM) 70° IRH	-	-
Oil, part no 901752	Medical white oil of paraffin type. Fulfills FDA 172.878 (a)	-	-

Table 6: Mechanical seals

Alternative	Inner seal	Outer seal
1	Corrosion resistant cemented carbide (WCCR)/ Aluminum oxide (Al ₂ O ₃)	Corrosion resistant cemented carbide (WCCR)/ Corrosion resistant cemented carbide (WCCR)
2	Corrosion resistant cemented carbide (WCCR)/ Corrosion resistant cemented carbide (WCCR)	Silicon carbide (RSiC)/ Silicon carbide (RSiC)
3	Corrosion resistant cemented carbide (WCCR)/ Corrosion resistant cemented carbide (WCCR)	Corrosion resistant cemented carbide (WCCR)/ Corrosion resistant cemented carbide (WCCR)

Surface treatment

Priming	Finish
Painted with a primer, see internal standard M0700.00.0002	Navy gray color NCS 5804-B07G. Two-component high-solid top coating, see internal standard M0700.00.0004 for standard painting and M0700.00.0008 for special painting.

Options

- Warm liquid version (non-explosion proof versions)
- Leakage sensor in the stator housing (FLS)
- Leakage sensor in the oil housing (CLS)
- Aqua cutting knife (chopper)
pressure class LT
- Surface treatment (Epoxy)
- Zinc anodes
- Other cables

Accessories

Discharge connections, adapters, hose connections, and other mechanical accessories
Electrical accessories such as pump controller, control panels, starters, monitoring relays, cables

2.2 Product description 3127.350/.390



Usage

A submersible chopper pump for liquid manure, fish waste, or heavily contaminated sewage and sludge. The N-hydraulic is fitted with a cutting insert ring. Both impeller and insert ring are manufactured in Hard-Iron™.

Denomination

Type	Non-explosion proof version	Explosion proof version	Pressure class	Installation types
Chopper Hard-Iron™	3127.350	3127.390	MT – Medium head HT – High head SH – Super head	P, S, T, Z, X

The pump can be used in the following installations:

- P Semipermanent, wet well arrangement with the pump installed on two guide bars. The connection to the discharge is automatic.
- S Portable semipermanent, wet well arrangement with hose coupling or flange for connection to the discharge pipeline.
- T Vertical permanent, dry well arrangement with flange connection to the suction and discharge piping.
- Z Horizontal permanent, dry well arrangement with flange connection to the suction and discharge piping.
- X Optional installation, wet or dry well arrangement without predetermined mechanical connection and with drilled flanges. Dry well arrangement requires cooling system or de-rated motor.

Application limits

Feature	Description
Liquid temperature	Maximum 40°C (104°F)
Liquid temperature, warm water version	Maximum 70°C (158°F)
Depth of immersion	Maximum 20 m (65 ft)
pH of the pumped liquid	5.5 - 14
Liquid density	Maximum 1100 kg/m ³

Motor data

Feature	Description
Motor type	Squirrel-cage induction motor

Feature	Description
Frequency	50 Hz
Power supply	3-phase
Starting method	<ul style="list-style-type: none"> • Direct on-line • Star-delta • Soft starter • Variable Frequency Drive (VFD)
Number of starts per hour	Maximum 30
Code compliance	IEC 60034-1
Voltage variation	<ul style="list-style-type: none"> • Continuously running: Maximum $\pm 5\%$ • Intermittent running: Maximum $\pm 10\%$
Voltage imbalance between phases	Maximum 2%
Stator insulation class	H (180°C, 356°F)

Cables

Application	Type
Direct-on-line start	Flygt SUBCAB® - a heavy duty 4 cores motor power cable with two twisted pair screened control cores. Conductor insulation rating of 90°C, which allows for increased current. Superior mechanical strength and high abrasion and tear resistant. Chemical resistant within pH 3-10 and ozone, oil, and flame resistant. Used up to 70°C water temperature. Cables < 10 mm ² with unscreened control cores.
Y/D start	Flygt SUBCAB® - a heavy duty 7 cores motor power cable with two twisted pair screened control cores. Conductor insulation rating of 90°C, which allows for increased current. Superior mechanical strength and high abrasion and tear resistant. Chemical resistant within pH 3-10 and ozone, oil, and flame resistant. Used up to 70°C water temperature. Cables < 7G6 mm ² with unscreened control cores.
Variable Frequency drive	Screened Flygt SUBCAB® - a heavy duty 4 screened cores motor power cable with four twisted pair screened control cores. Conductor insulation rating of 90°C, which allows for increased current. Superior mechanical strength and high abrasion and tear resistant. Chemical resistant within pH 3-10 and ozone, oil, and flame resistant. Used up to 70°C water temperature.

Monitoring equipment

Thermal contacts opening temperature 125°C (257°F)

Materials

Table 7: Major parts except mechanical seals

Denomination	Material	ASTM	EN
Major castings	Cast iron, gray	35B	GJL-250
Pump housing	Cast iron, gray	35B	GJL-250
Impeller	Cast iron, Hard-Iron™	A 532 IIIA	GJN-HB555(XCR23)
Insert ring, alternative 1	Cast iron, Hard-Iron™	A 532 IIIA	GJN-HB555(XCR23)
Insert ring, alternative 2	Cast iron, Hard-Iron™	A 532 IIIA	GJN-HB555(XCR23)
Lifting handle	Stainless steel	AISI 316L	1.4404, 1.4432, ...

Denomination	Material	ASTM	EN
Shaft	Stainless steel	AISI 431	1.4057+QT800
Screws and nuts	Stainless steel, A4	AISI 316L, 316, 316Ti	1.4401, 1.4404, ...
O-rings, alternative 1	Nitrile rubber (NBR) 70° IRH	-	-
O-rings, alternative 2	Fluorinated rubber (FPM) 70° IRH	-	-
Oil, part no 901752	Medical white oil of paraffin type. Fulfills FDA 172.878 (a)	-	-

Table 8: Mechanical seals

Alternative	Inner seal	Outer seal
1	Corrosion resistant cemented carbide (WCCR)/ Aluminum oxide (Al ₂ O ₃)	Corrosion resistant cemented carbide (WCCR)/ Corrosion resistant cemented carbide (WCCR)
2	Corrosion resistant cemented carbide (WCCR)/ Corrosion resistant cemented carbide (WCCR)	Silicon carbide (RSiC)/ Silicon carbide (RSiC)
3	Corrosion resistant cemented carbide (WCCR)/ Corrosion resistant cemented carbide (WCCR)	Corrosion resistant cemented carbide (WCCR)/ Corrosion resistant cemented carbide (WCCR)

Surface treatment

Priming	Finish
Painted with a primer, see internal standard M0700.00.0002	Navy gray color NCS 5804-B07G. Two-component high-solid top coating, see internal standard M0700.00.0004 for standard painting and M0700.00.0008 for special painting.

Options

- Warm liquid version (non-explosion proof versions)
- Leakage sensor in the stator housing (FLS)
- Leakage sensor in the oil housing (CLS)
- Aqua cutting knife (chopper)
pressure class MT
- Surface treatment (Epoxy)
- Zinc anodes
- Other cables

Accessories

Discharge connections, adapters, hose connections, and other mechanical accessories
Electrical accessories such as pump controller, control panels, starters, monitoring relays, cables

2.3 Motor rating and performance curves 3127.182/.091

These are examples of motor rating and curves. For more information, please contact your local sales and service representative.

Star-delta starting current is 1/3 of Direct on-line starting current.

LT

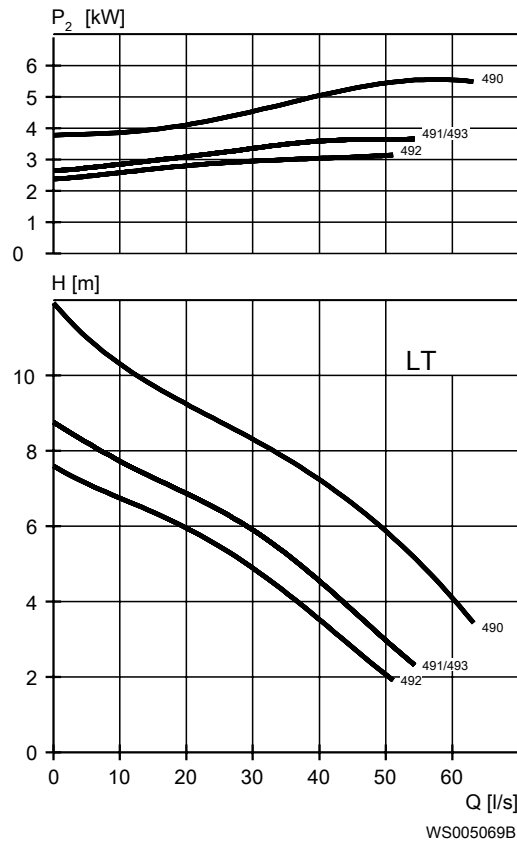

Table 9: 400 V, 50 Hz, 3-phase

Rated power, kW	Rated power, hp	Curve/ Impeller No	Revolutions per minute, rpm	Rated current, A	Starting current, A	Power factor, $\cos \phi$	Installation
4.7	6.3	491	1460	10	73	0.78	J,P,S,X
4.7	6.3	492	1460	10	73	0.78	J,P,S,X
4.7	6.3	493	1460	10	73	0.78	J,P,S,X
5.9	7.9	490	1450	13	76	0.81	J,P,S,X
5.9	7.9	491	1450	13	76	0.81	J,P,S,X
5.9	7.9	492	1450	13	76	0.81	J,P,S,X
5.9	7.9	493	1450	13	76	0.81	J,P,S,X

2.4 Motor rating and performance curves 3127.350/.390

These are examples of motor rating and curves. For more information, please contact your local sales and service representative.

Star-delta starting current is 1/3 of Direct on-line starting current.

MT

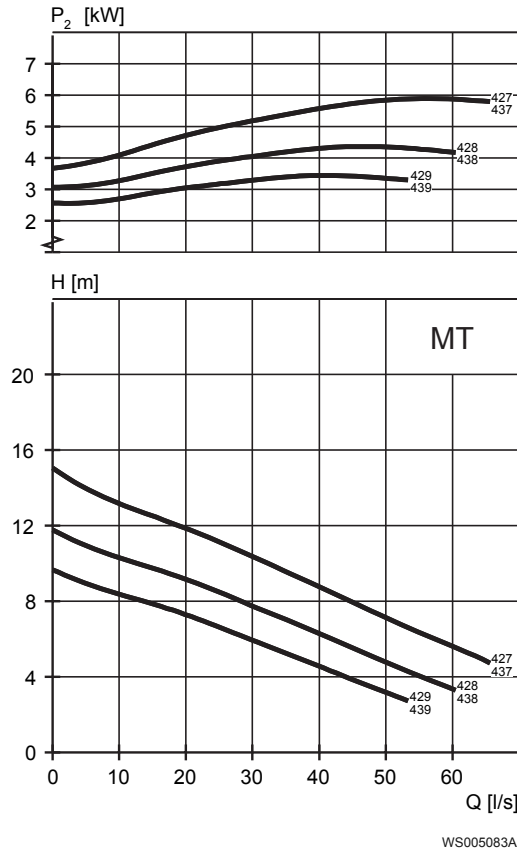

Curves for long fibrous manure: 427, 428, 429

Table 10: 400 V, 50 Hz, 3-phase

Rated power, kW	Rated power, hp	Curve/ Impeller No	Revolutions per minute, rpm	Rated current, A	Starting current, A	Power factor, cos φ	Installation
4.7	6.3	428	1445	9.6	56	0.86	P,S,T,X,Z
4.7	6.3	429	1445	9.6	56	0.86	P,S,T,X,Z
4.7	6.3	438	1445	9.6	56	0.86	P,S,T,X,Z
4.7	6.3	439	1445	9.6	56	0.86	P,S,T,X,Z
5.9	7.9	427	1450	13	76	0.81	P,S,T,X,Z
5.9	7.9	437	1450	13	76	0.81	P,S,T,X,Z

HT

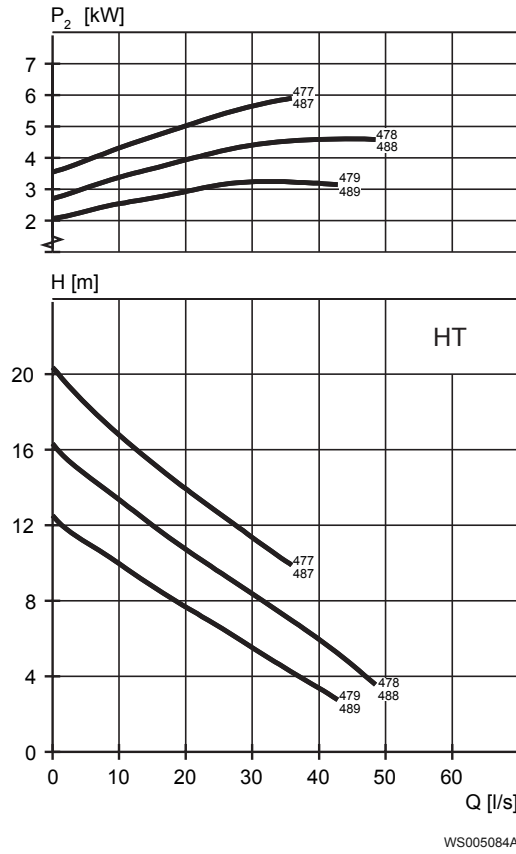

Curves for long fibrous manure: 477, 478, 479

Table 11: 400 V, 50 Hz, 3-phase

Rated power, kW	Rated power, hp	Curve/ Impeller No	Revolutions per minute, rpm	Rated current, A	Starting current, A	Power factor, cos φ	Installation
4.7	6.3	478	1445	9.6	56	0.86	P,S,T,X,Z
4.7	6.3	479	1445	9.6	56	0.86	P,S,T,X,Z
4.7	6.3	488	1445	9.6	56	0.86	P,S,T,X,Z
4.7	6.3	489	1445	9.6	56	0.86	P,S,T,X,Z
5.9	7.9	477	1450	13	76	0.81	P,S,T,X,Z
5.9	7.9	486	1450	13	76	0.81	P,S,T,X,Z
5.9	7.9	487	1450	13	76	0.81	P,S,T,X,Z

SH

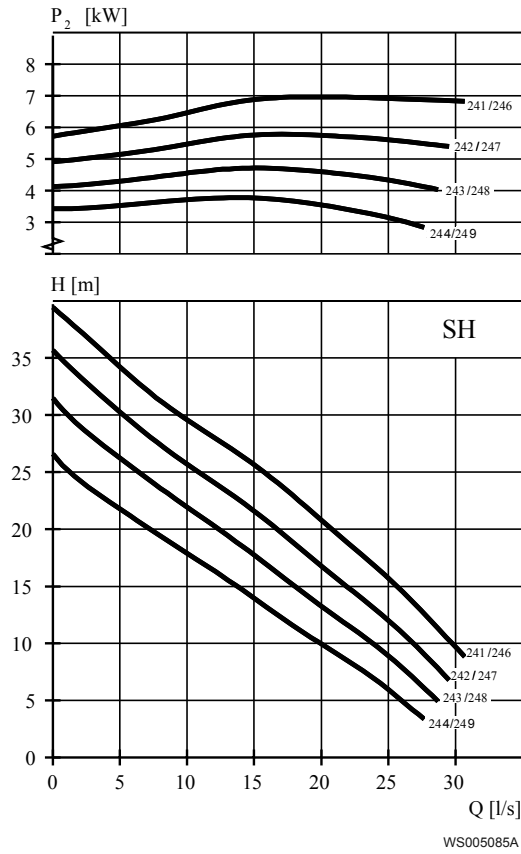

Curves for long fibrous manure: 241, 242, 243, 244

Table 12: 400 V, 50 Hz, 3-phase

Rated power, kW	Rated power, hp	Curve/ Impeller No	Revolutions per minute, rpm	Rated current, A	Starting current, A	Power factor, cos ϕ	Installation
7.4	9.9	241	2900	14	114	0.89	P,S,T,X,Z
7.4	9.9	242	2900	14	114	0.89	P,S,T,X,Z
7.4	9.9	243	2900	14	114	0.89	P,S,T,X,Z
7.4	9.9	244	2900	14	114	0.89	P,S,T,X,Z
7.4	9.9	246	2900	14	114	0.89	P,S,T,X,Z
7.4	9.9	247	2900	14	114	0.89	P,S,T,X,Z
7.4	9.9	248	2900	14	114	0.89	P,S,T,X,Z
7.4	9.9	249	2900	14	114	0.89	P,S,T,X,Z

3 F-pump, Premium Efficiency Motor (IE3)

3.1 Product description



Usage

A submersible chopper pump for liquid manure, fish waste, or heavily contaminated sewage and sludge. The N-hydraulic is fitted with a cutting insert ring. Both impeller and insert ring are manufactured in Hard-Iron™.

Denomination

Type	Non-explosion proof version	Explosion proof version	Pressure class	Installation types
Chopper Hard-Iron™	3127.840	3127.850	MT – Medium head HT – High head SH – Super head	P, S, T, Z, X

The pump can be used in the following installations:

- P Semipermanent, wet well arrangement with the pump installed on two guide bars. The connection to the discharge is automatic.
- S Portable semipermanent, wet well arrangement with hose coupling or flange for connection to the discharge pipeline.
- T Vertical permanent, dry well arrangement with flange connection to the suction and discharge piping.
- Z Horizontal permanent, dry well arrangement with flange connection to the suction and discharge piping.
- X Optional installation, wet or dry well arrangement without predetermined mechanical connection and with drilled flanges. Dry well arrangement requires cooling system or de-rated motor.

Application limits

Feature	Description
Liquid temperature	Maximum 40°C (104°F)
Depth of immersion	Maximum 20 m (65 ft)
pH of the pumped liquid	5.5 - 14

Feature	Description
Liquid density	Maximum 1100 kg/m ³

Motor data

Feature	Description
Motor type	Line started permanent magnet motor (LSPM)
Frequency	50 Hz
Power supply	3-phase
Starting method	<ul style="list-style-type: none"> • Direct on-line • Star-delta • Soft starter • Variable Frequency Drive (VFD)
Number of starts per hour	Maximum 30
Code compliance	IEC 60034-1
Voltage variation	<ul style="list-style-type: none"> • Continuously running: Maximum $\pm 5\%$ • Intermittent running: Maximum $\pm 10\%$
Voltage imbalance between phases	Maximum 2%
Stator insulation class	H (180°C, 356°F)

Cables

Application	Type
Direct-on-line start	Flygt SUBCAB® - a heavy duty 4 cores motor power cable with two twisted pair screened control cores. Conductor insulation rating of 90°C, which allows for increased current. Superior mechanical strength and high abrasion and tear resistant. Chemical resistant within pH 3-10 and ozone, oil, and flame resistant. Used up to 70°C water temperature. Cables < 10 mm ² with unscreened control cores.
Y/D start	Flygt SUBCAB® - a heavy duty 7 cores motor power cable with two twisted pair screened control cores. Conductor insulation rating of 90°C, which allows for increased current. Superior mechanical strength and high abrasion and tear resistant. Chemical resistant within pH 3-10 and ozone, oil, and flame resistant. Used up to 70°C water temperature. Cables < 7G6 mm ² with unscreened control cores.
Variable Frequency drive	Screened Flygt SUBCAB® - a heavy duty 4 screened cores motor power cable with four twisted pair screened control cores. Conductor insulation rating of 90°C, which allows for increased current. Superior mechanical strength and high abrasion and tear resistant. Chemical resistant within pH 3-10 and ozone, oil, and flame resistant. Used up to 70°C water temperature.

Monitoring equipment

- Thermal contacts opening temperature 125°C (257°F)

Materials

Table 13: Major parts except mechanical seals

Denomination	Material	ASTM	EN
Major castings	Cast iron, gray	35B	GJL-250

Denomination	Material	ASTM	EN
Pump housing	Cast iron, gray	35B	GJL-250
Impeller	Cast iron, Hard-Iron™	A 532 IIIA	GJN-HB555(XCR23)
Insert ring, alternative 1	Cast iron, Hard-Iron™	A 532 IIIA	GJN-HB555(XCR23)
Insert ring, alternative 2	Cast iron, Hard-Iron™	A 532 IIIA	GJN-HB555(XCR23)
Lifting handle	Stainless steel	AISI 316L	1.4404, 1.4432, ...
Shaft	Stainless steel	AISI 431	1.4057+QT800
Screws and nuts	Stainless steel, A4	AISI 316L, 316, 316Ti	1.4401, 1.4404, ...
O-rings, alternative 1	Nitrile rubber (NBR) 70° IRH	-	-
O-rings, alternative 2	Fluorinated rubber (FPM) 70° IRH	-	-
Oil, part no 901752	Medical white oil of paraffin type. Fulfills FDA 172.878 (a)	-	-

Table 14: Mechanical seals

Alternative	Inner seal	Outer seal
1	Corrosion resistant cemented carbide (WCCR)/ Aluminum oxide (Al ₂ O ₃)	Corrosion resistant cemented carbide (WCCR)/ Corrosion resistant cemented carbide (WCCR)
2	Corrosion resistant cemented carbide (WCCR)/ Corrosion resistant cemented carbide (WCCR)	Silicon carbide (RSiC)/ Silicon carbide (RSiC)
3	Corrosion resistant cemented carbide (WCCR)/ Corrosion resistant cemented carbide (WCCR)	Corrosion resistant cemented carbide (WCCR)/ Corrosion resistant cemented carbide (WCCR)

Surface treatment

Priming	Finish
Painted with a primer, see internal standard M0700.00.0002	Navy gray color NCS 5804-B07G. Two-component high-solid top coating, see internal standard M0700.00.0004 for standard painting and M0700.00.0008 for special painting.

Options

- Leakage sensor in the stator housing (FLS)
- Leakage sensor in the oil housing (CLS)
- Aqua cutting knife (chopper)
pressure class MT
- Surface treatment (Epoxy)
- Zinc anodes
- Other cables

Accessories

Discharge connections, adapters, hose connections, and other mechanical accessories
Electrical accessories such as pump controller, control panels, starters, monitoring relays, cables

3.2 Motor rating and performance curves

These are examples of motor rating and curves. For more information, please contact your local sales and service representative.

Star-delta starting current is 1/3 of Direct on-line starting current.

MT

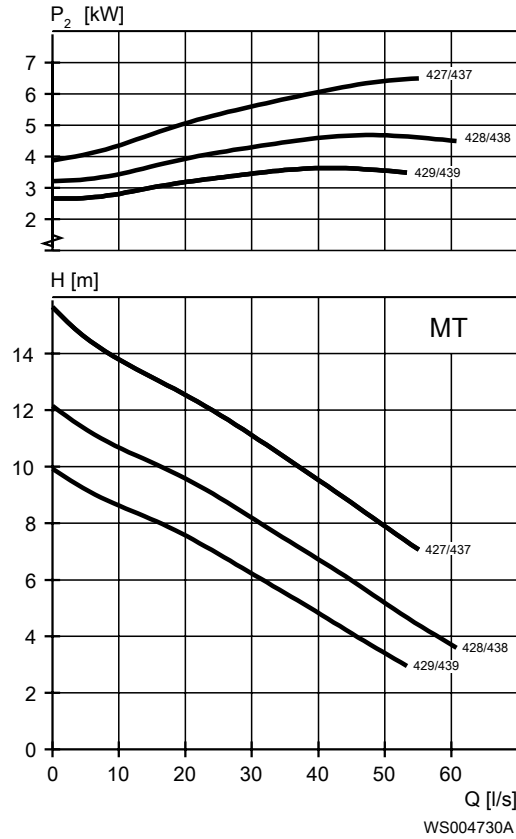

Curves for long fibrous manure: 427, 428, 429

Table 15: 400 V, 50 Hz, 3-phase

Rated power, kW	Rated power, hp	Curve/ Impeller No	Revolutions per minute, rpm	Rated current, A	Starting current, A	Power factor, cos φ	Installation
5	6.7	428	1500	8.9	76	0.89	P,S,X
5	6.7	429	1500	8.9	76	0.89	P,S,X
5	6.7	438	1500	8.9	76	0.89	P,S,X
5	6.7	439	1500	8.9	76	0.89	P,S,X
5.5	7.4	428	1500	9.6	76	0.9	T,Z
5.5	7.4	429	1500	9.6	76	0.9	T,Z
5.5	7.4	438	1500	9.6	76	0.9	T,Z
5.5	7.4	439	1500	9.6	76	0.9	T,Z
6.5	8.7	427	1500	11	76	0.91	T,Z
6.5	8.7	427	1500	11	76	0.91	P,S,X
6.5	8.7	428	1500	11	76	0.91	P,S,X
6.5	8.7	429	1500	11	76	0.91	P,S,X
6.5	8.7	437	1500	11	76	0.91	T,Z
6.5	8.7	437	1500	11	76	0.91	P,S,X
6.5	8.7	438	1500	11	76	0.91	P,S,X
6.5	8.7	439	1500	11	76	0.91	P,S,X

HT

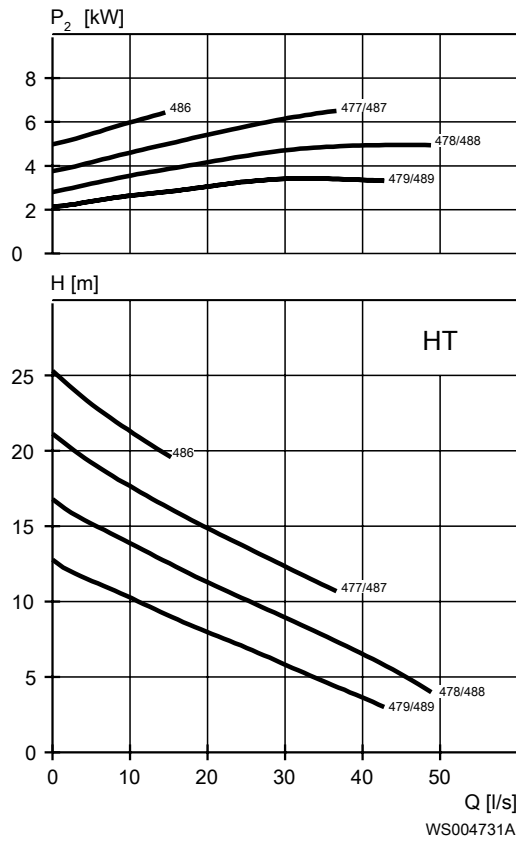

Curves for long fibrous manure: 477, 478, 479

Table 16: 400 V, 50 Hz, 3-phase

Rated power, kW	Rated power, hp	Curve/ Impeller No	Revolutions per minute, rpm	Rated current, A	Starting current, A	Power factor, cos φ	Installation
5	6.7	478	1500	8.9	76	0.89	P,S,X
5	6.7	479	1500	8.9	76	0.89	P,S,X
5	6.7	488	1500	8.9	76	0.89	P,S,X
5	6.7	489	1500	8.9	76	0.89	P,S,X
5.5	7.4	478	1500	9.6	76	0.9	T,Z
5.5	7.4	479	1500	9.6	76	0.9	T,Z
5.5	7.4	488	1500	9.6	76	0.9	T,Z
5.5	7.4	489	1500	9.6	76	0.9	T,Z
6.5	8.7	477	1500	11	76	0.91	T,Z
6.5	8.7	477	1500	11	76	0.91	P,S,X
6.5	8.7	478	1500	11	76	0.91	P,S,X
6.5	8.7	479	1500	11	76	0.91	P,S,X
6.5	8.7	486	1500	11	76	0.91	P,S,X
6.5	8.7	486	1500	11	76	0.91	T,Z
6.5	8.7	487	1500	11	76	0.91	T,Z
6.5	8.7	487	1500	11	76	0.91	P,S,X
6.5	8.7	488	1500	11	76	0.91	P,S,X
6.5	8.7	489	1500	11	76	0.91	P,S,X

SH

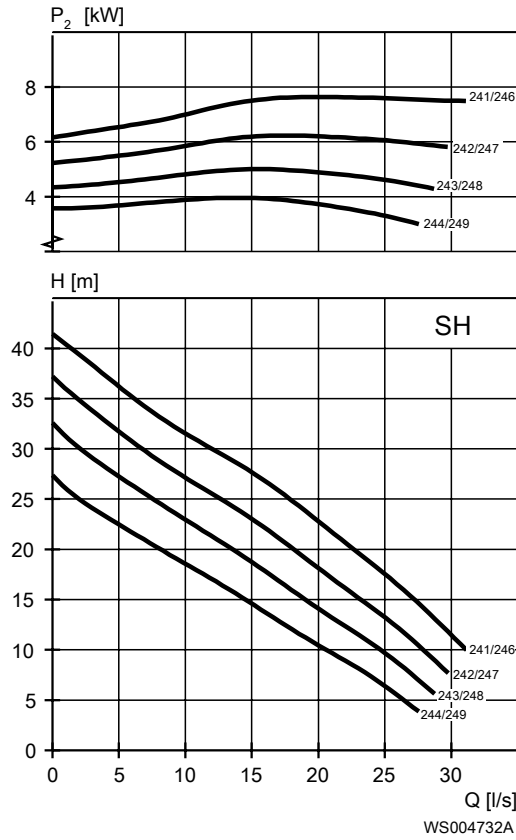

Curves for long fibrous manure: 241, 242, 243, 244

Table 17: 400 V, 50 Hz, 3-phase

IE3 compliance is based on Y-connected stator.

Rated power, kW	Rated power, hp	Curve/ Impeller No	Revolutions per minute, rpm	Rated current, A	Starting current, A	Power factor, cos φ	Installation
8.5	11.4	241	3000	16	126	0.84	P,S,X,T,Z
8.5	11.4	242	3000	16	126	0.84	P,S,X,T,Z
8.5	11.4	243	3000	16	126	0.84	P,S,X,T,Z
8.5	11.4	244	3000	16	126	0.84	P,S,X,T,Z
8.5	11.4	246	3000	16	126	0.84	P,S,X,T,Z
8.5	11.4	247	3000	16	126	0.84	P,S,X,T,Z
8.5	11.4	248	3000	16	126	0.84	P,S,X,T,Z
8.5	11.4	249	3000	16	126	0.84	P,S,X,T,Z

4 M-pump

4.1 Product description



Usage

A submersible pump for wastewater containing solids that need to be macerated. The impeller is equipped with a grinder device.

Denomination

Type	Non-explosion proof version	Explosion proof version	Pressure class	Installation types
Gray iron Grinder	3127.170	3127.890	LT – Low head HT – High head	F, P

The pump can be used in the following installations:

- F Free standing semipermanent, wet well arrangement where the pump is placed on a firm surface.
- P Semipermanent, wet well arrangement with the pump installed on two guide bars. The connection to the discharge is automatic.

Application limits

Feature	Description
Liquid temperature	Maximum 40°C (104°F)
Depth of immersion	Maximum 20 m (65 ft)
pH of the pumped liquid	5.5 - 14
Liquid density	Maximum 1100 kg/m ³

Motor data

Feature	Description
Motor type	Squirrel-cage induction motor
Frequency	50 Hz
Power supply	3-phase
Starting method	<ul style="list-style-type: none"> • Direct on-line • Star-delta • Soft starter
Number of starts per hour	Maximum 30

Feature	Description
Code compliance	IEC 60034-1
Voltage variation	<ul style="list-style-type: none"> Continuously running: Maximum $\pm 5\%$ Intermittent running: Maximum $\pm 10\%$
Voltage imbalance between phases	Maximum 2%
Stator insulation class	H (180°C, 356°F)

Cables

Application	Type
Direct-on-line start	Flygt SUBCAB® - a heavy duty 4 cores motor power cable with two twisted pair screened control cores. Conductor insulation rating of 90°C, which allows for increased current. Superior mechanical strength and high abrasion and tear resistant. Chemical resistant within pH 3-10 and ozone, oil, and flame resistant. Used up to 70°C water temperature. Cables < 10 mm ² with unscreened control cores.
Y/D start	Flygt SUBCAB® - a heavy duty 7 cores motor power cable with two twisted pair screened control cores. Conductor insulation rating of 90°C, which allows for increased current. Superior mechanical strength and high abrasion and tear resistant. Chemical resistant within pH 3-10 and ozone, oil, and flame resistant. Used up to 70°C water temperature. Cables < 7G6 mm ² with unscreened control cores.

Monitoring equipment

Thermal contacts opening temperature 125°C (257°F)

Materials

Table 18: Major parts except mechanical seals

Denomination	Material	ASTM	EN
Major castings	Cast iron, gray	35B	GJL-250
Pump housing	Cast iron, gray	35B	GJL-250
Impeller, alternative 1	Cast iron, gray	30B	GJL-200
Impeller, alternative 2	Cast iron, gray	35B	GJL-250
Cutter wheel	Cast iron, Hard-Iron™	A 532 IIIA	GJN-HB555(XCR23)
Cutter plate	Stainless steel	-	-
Lifting handle	Stainless steel	AISI 316L	1.4404, 1.4432, ...
Shaft	Stainless steel	AISI 431	1.4057+QT800
Screws and nuts	Stainless steel, A4	AISI 316L, 316, 316Ti	1.4401, 1.4404, ...
O-rings	Nitrile rubber (NBR) 70° IRH	-	-
Oil, part no 901752	Medical white oil of paraffin type. Fulfills FDA 172.878 (a)	-	-

Table 19: Mechanical seals

Inner seal	Outer seal
Aluminum oxide (Al ₂ O ₃)/ Corrosion resistant cemented carbide (WCCR)	Corrosion resistant cemented carbide (WCCR)/ Corrosion resistant cemented carbide (WCCR)

Surface treatment

Priming	Finish
Painted with a primer, see internal standard M0700.00.0002	Navy gray color NCS 5804-B07G. Two-component high-solid top coating, see internal standard M0700.00.0004 for standard painting and M0700.00.0008 for special painting.

Options

- Leakage sensor in the stator housing (FLS)
- Leakage sensor in the oil housing (CLS)
- Surface treatment (Epoxy)
- Zinc anodes
- Other cables

Accessories

Discharge connections, adapters, hose connections, and other mechanical accessories
Electrical accessories such as pump controller, control panels, starters, monitoring relays, cables

4.2 Motor rating and performance curves

These are examples of motor rating and curves. For more information, please contact your local sales and service representative.

Star-delta starting current is 1/3 of Direct on-line starting current.

LT

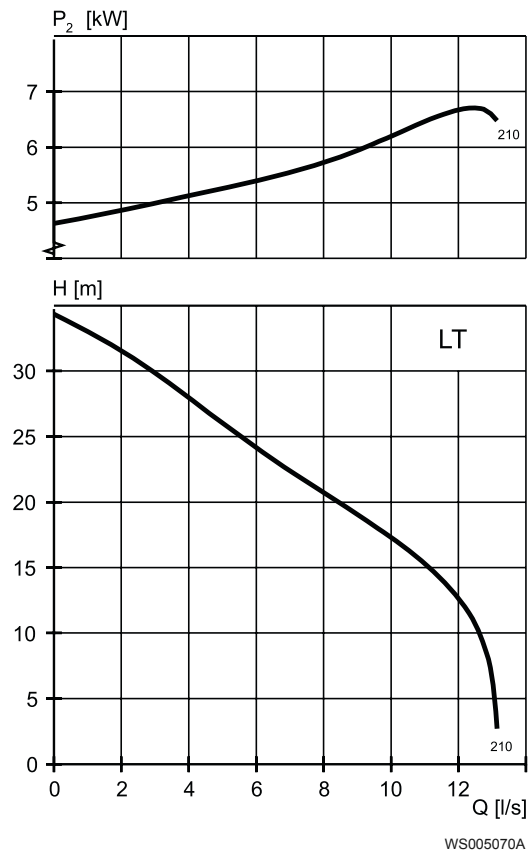

Table 20: 400 V, 50 Hz, 3-phase

Rated power, kW	Rated power, hp	Curve/ Impeller No	Revolutions per minute, rpm	Rated current, A	Starting current, A	Power factor, cos φ	Installation
7.4	9.9	210	2920	16	146	0.78	F,P
7.4	9.9	210	2885	13	100	0.92	F,P
7.4	9.9	210	2900	14	114	0.89	F,P
10.9	14.6	210	2875	22	146	0.84	F,P

HT

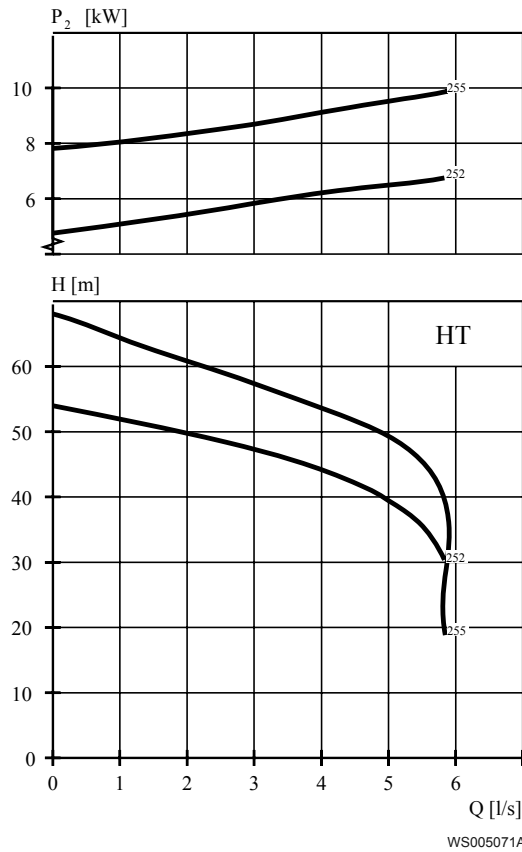

Table 21: 400 V, 50 Hz, 3-phase

Rated power, kW	Rated power, hp	Curve/ Impeller No	Revolutions per minute, rpm	Rated current, A	Starting current, A	Power factor, cos φ	Installation
7.4	9.9	252	2920	16	146	0.78	F,P
7.4	9.9	252	2885	13	100	0.92	F,P
7.4	9.9	252	2900	14	114	0.89	F,P
10.9	14.6	252	2875	22	146	0.84	F,P
10.9	14.6	255	2875	22	146	0.84	F,P

5 N-pump, Standard Motor

5.1 Product description



Usage

Installation type P, S, T, Z A submersible pump for efficient pumping of clean water, surface water, and wastewater containing solids or long-fibered material. The pump is designed for sustained high efficiency. For abrasive media, Hard-Iron™ is required. Stainless steel N-impeller is available as an option.

Installation type L A submersible pump for a mixed flow of clean water, surface water, or storm water. Intended for high flow and low head applications, in column installation. The pump is designed for sustained high efficiency.

Denomination

Table 22: Adaptive N-hydraulic

Impeller material	Non-explosion proof version	Explosion proof version	Pressure class	Installation types
Hard-Iron™	3127.060	3127.070	LT – Low head MT – Medium head HT – High head SH – Super head	L, P, S, T, Z, X
Cast iron, gray	3127.161	3127.191	LT – Low head MT – Medium head HT – High head SH – Super head	L, P, S, T, Z, X
Stainless steel	3127.761	3127.771	LT – Low head MT – Medium head HT – High head SH – Super head	L, P, S, T, Z, X

The pump can be used in the following installations:

- L Vertical semipermanent, wet well column pipe arrangement where the well is divided into a suction part and a discharge part. Pump end equipped with guide vanes.

- P Semipermanent, wet well arrangement with the pump installed on two guide bars. The connection to the discharge is automatic.
- S Portable semipermanent, wet well arrangement with hose coupling or flange for connection to the discharge pipeline.
- T Vertical permanent, dry well arrangement with flange connection to the suction and discharge piping.
- Z Horizontal permanent, dry well arrangement with flange connection to the suction and discharge piping.
- X Optional installation, wet or dry well arrangement without predetermined mechanical connection and with drilled flanges. Dry well arrangement requires cooling system or de-rated motor.

Application limits

Feature	Description
Liquid temperature	Maximum 40°C (104°F)
Liquid temperature, warm water version	Maximum 70°C (158°F)
Depth of immersion	Maximum 20 m (65 ft)
pH of the pumped liquid	5.5 - 14
Liquid density	Maximum 1100 kg/m ³

Motor data

Feature	Description
Motor type	Squirrel-cage induction motor
Frequency	50 Hz
Power supply	3-phase
Starting method	<ul style="list-style-type: none"> • Direct on-line • Star-delta • Soft starter • Variable Frequency Drive (VFD)
Number of starts per hour	Maximum 30
Code compliance	IEC 60034-1
Voltage variation	<ul style="list-style-type: none"> • Continuously running: Maximum $\pm 5\%$ • Intermittent running: Maximum $\pm 10\%$
Voltage imbalance between phases	Maximum 2%
Stator insulation class	H (180°C, 356°F)

Motor encapsulation

Motor encapsulation is in accordance with IP68.

Cables

Application	Type
Direct-on-line start	Flygt SUBCAB® - a heavy duty 4 cores motor power cable with two twisted pair screened control cores. Conductor insulation rating of 90°C, which allows for increased current. Superior mechanical strength and high abrasion and tear resistant. Chemical resistant within pH 3-10 and ozone, oil, and flame resistant. Used up to 70°C water temperature. Cables < 10 mm ² with unscreened control cores.

Application	Type
Y/D start	Flygt SUBCAB® - a heavy duty 7 cores motor power cable with two twisted pair screened control cores. Conductor insulation rating of 90°C, which allows for increased current. Superior mechanical strength and high abrasion and tear resistant. Chemical resistant within pH 3-10 and ozone, oil, and flame resistant. Used up to 70°C water temperature. Cables < 766 mm ² with unscreened control cores.
Variable Frequency drive	Screened Flygt SUBCAB® - a heavy duty 4 screened cores motor power cable with four twisted pair screened control cores. Conductor insulation rating of 90°C, which allows for increased current. Superior mechanical strength and high abrasion and tear resistant. Chemical resistant within pH 3-10 and ozone, oil, and flame resistant. Used up to 70°C water temperature.

Monitoring equipment

Thermal contacts opening temperature 125°C (257°F)

Materials

Table 23: Major parts except mechanical seals

Denomination	Material	ASTM	EN
Major castings	Cast iron, gray	35B	GJL-250
Pump housing	Cast iron, gray	35B	GJL-250
Impeller, alternative 1	Cast iron, gray	35B	GJL-250
Impeller, alternative 2	Cast iron, Hard-Iron™	A 532 IIIA	GJN-HB555(XCR23)
Impeller, alternative 3	Stainless steel, Duplex	CD-4MCuN	10283:2010 -1.4474
Insert ring, alternative 1	Cast iron, gray	35B	GJL-250
Insert ring, alternative 2	Cast iron, Hard-Iron™	A 532 IIIA	GJN-HB555(XCR23)
Lifting handle	Stainless steel	AISI 316L	1.4404,1.4432, ...
Shaft	Stainless steel	AISI 431	1.4057+QT800
Screws and nuts	Stainless steel, A4	AISI 316L, 316, 316Ti	1.4401,1.4404, ...
O-rings, alternative 1	Nitrile rubber (NBR) 70° IRH	-	-
O-rings, alternative 2	Fluorinated rubber (FPM) 70° IRH	-	-
Oil, part no 901752	Medical white oil of paraffin type. Fulfills FDA 172.878 (a)	-	-

Table 24: Mechanical seals

Alternative	Inner seal	Outer seal
1	Corrosion resistant cemented carbide (WCCR)/ Aluminum oxide (Al ₂ O ₃)	Corrosion resistant cemented carbide (WCCR)/ Corrosion resistant cemented carbide (WCCR)
2	Corrosion resistant cemented carbide (WCCR)/ Corrosion resistant cemented carbide (WCCR)	Silicon carbide (RSiC)/ Silicon carbide (RSiC)
3	Corrosion resistant cemented carbide (WCCR)/ Corrosion resistant cemented carbide (WCCR)	Corrosion resistant cemented carbide (WCCR)/ Corrosion resistant cemented carbide (WCCR)

Surface treatment

Priming	Finish
Painted with a primer, see internal standard M0700.00.0002	Navy gray color NCS 5804-B07G. Two-component high-solid top coating, see internal standard M0700.00.0004 for standard painting and M0700.00.0008 for special painting.

Options

- Warm liquid version (non-explosion proof versions)
- Leakage sensor in the stator housing (FLS)
- Leakage sensor in the oil housing (CLS)
- Surface treatment (Epoxy)
- Zinc anodes
- Other cables

Accessories

Discharge connections, adapters, hose connections, and other mechanical accessories
 Electrical accessories such as pump controller, control panels, starters, monitoring relays, cables

5.2 Motor rating and performance curves

These are examples of motor rating and curves. For more information, please contact your local sales and service representative.

Star-delta starting current is 1/3 of Direct on-line starting current.

LT

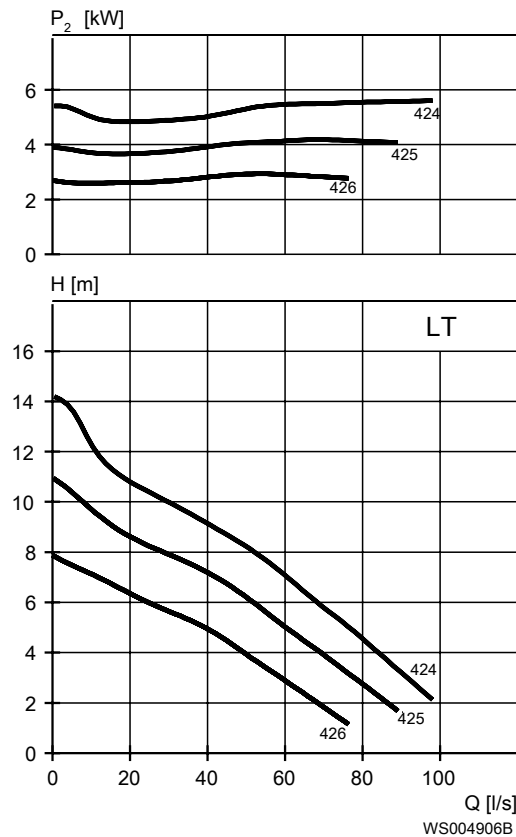

Table 25: 400 V, 50 Hz, 3-phase

Rated power, kW	Rated power, hp	Curve/ Impeller No	Revolutions per minute, rpm	Rated current, A	Starting current, A	Power factor, cos ϕ	Installation
4	5.4	426	1455	8.3	56	0.84	T,Z
4	5.4	426	1450	8.0	50	0.86	T,Z
4	5.4	426	1465	9.4	73	0.74	T,Z
4.7	6.3	425	1445	9.6	56	0.86	P,S,X
4.7	6.3	425	1440	9.4	50	0.88	P,S,X
4.7	6.3	425	1460	11	76	0.76	T,Z
4.7	6.3	425	1455	9.3	62	0.87	T,Z
4.7	6.3	425	1460	10	73	0.78	P,S,X
4.7	6.3	425	1465	11	91	0.74	T,Z
4.7	6.3	426	1445	9.6	56	0.86	P,S,X
4.7	6.3	426	1445	9.6	56	0.86	L
4.7	6.3	426	1440	9.4	50	0.88	P,S,X
4.7	6.3	426	1440	9.4	50	0.88	L
4.7	6.3	426	1460	11	76	0.76	T,Z
4.7	6.3	426	1455	9.3	62	0.87	T,Z
4.7	6.3	426	1460	10	73	0.78	L
4.7	6.3	426	1460	10	73	0.78	P,S,X
4.7	6.3	426	1465	11	91	0.74	T,Z
5.9	7.9	424	1450	13	76	0.81	L
5.9	7.9	424	1450	13	76	0.81	P,S,X
5.9	7.9	424	1450	13	76	0.81	T,Z
5.9	7.9	424	1440	12	62	0.88	L
5.9	7.9	424	1440	12	62	0.88	P,S,X
5.9	7.9	424	1440	12	62	0.88	T,Z
5.9	7.9	424	1460	13	91	0.79	L
5.9	7.9	424	1460	13	91	0.79	P,S,X
5.9	7.9	424	1460	13	91	0.79	T,Z
5.9	7.9	425	1450	13	76	0.81	P,S,X
5.9	7.9	425	1450	13	76	0.81	L
5.9	7.9	425	1440	12	62	0.88	P,S,X
5.9	7.9	425	1440	12	62	0.88	L
5.9	7.9	425	1460	13	91	0.79	L
5.9	7.9	425	1460	13	91	0.79	P,S,X
5.9	7.9	426	1450	13	76	0.81	P,S,X
5.9	7.9	426	1450	13	76	0.81	L
5.9	7.9	426	1440	12	62	0.88	P,S,X
5.9	7.9	426	1440	12	62	0.88	L
5.9	7.9	426	1460	13	91	0.79	P,S,X
5.9	7.9	426	1460	13	91	0.79	L
7.5	10.1	424	1435	16	76	0.84	L
7.5	10.1	425	1435	16	76	0.84	L

Rated power, kW	Rated power, hp	Curve/ Impeller No	Revolutions per minute, rpm	Rated current, A	Starting current, A	Power factor, cos φ	Installation
7.5	10.1	426	1435	16	76	0.84	L

MT

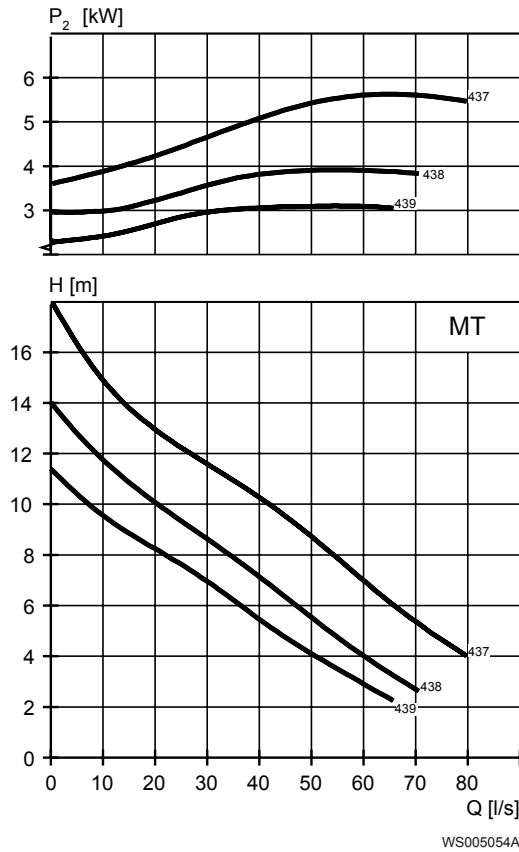

Table 26: 400 V, 50 Hz, 3-phase

Rated power, kW	Rated power, hp	Curve/ Impeller No	Revolutions per minute, rpm	Rated current, A	Starting current, A	Power factor, cos φ	Installation
4	5.4	439	1455	8.3	56	0.84	T,Z
4	5.4	439	1465	9.4	73	0.74	T,Z
4	5.4	439	1450	8.0	50	0.86	T,Z
4.7	6.3	438	1445	9.6	56	0.86	P,S,X
4.7	6.3	438	1460	10	73	0.78	P,S,X
4.7	6.3	438	1440	9.4	50	0.88	P,S,X
4.7	6.3	438	1460	11	76	0.76	T,Z
4.7	6.3	438	1465	11	91	0.74	T,Z
4.7	6.3	438	1455	9.3	62	0.87	T,Z
4.7	6.3	439	1445	9.6	56	0.86	P,S,X
4.7	6.3	439	1460	10	73	0.78	P,S,X
4.7	6.3	439	1440	9.4	50	0.88	P,S,X
4.7	6.3	439	1460	11	76	0.76	T,Z
4.7	6.3	439	1465	11	91	0.74	T,Z
4.7	6.3	439	1455	9.3	62	0.87	T,Z

Rated power, kW	Rated power, hp	Curve/ Impeller No	Revolutions per minute, rpm	Rated current, A	Starting current, A	Power factor, cos ϕ	Installation
5.9	7.9	437	1450	13	76	0.81	T,Z
5.9	7.9	437	1450	13	76	0.81	P,S,X
5.9	7.9	437	1460	13	91	0.79	T,Z
5.9	7.9	437	1460	13	91	0.79	P,S,X
5.9	7.9	437	1440	12	62	0.88	P,S,X
5.9	7.9	437	1440	12	62	0.88	T,Z
5.9	7.9	438	1450	13	76	0.81	P,S,X
5.9	7.9	438	1460	13	91	0.79	P,S,X
5.9	7.9	438	1440	12	62	0.88	P,S,X
5.9	7.9	439	1450	13	76	0.81	P,S,X
5.9	7.9	439	1460	13	91	0.79	P,S,X
5.9	7.9	439	1440	12	62	0.88	P,S,X

HT

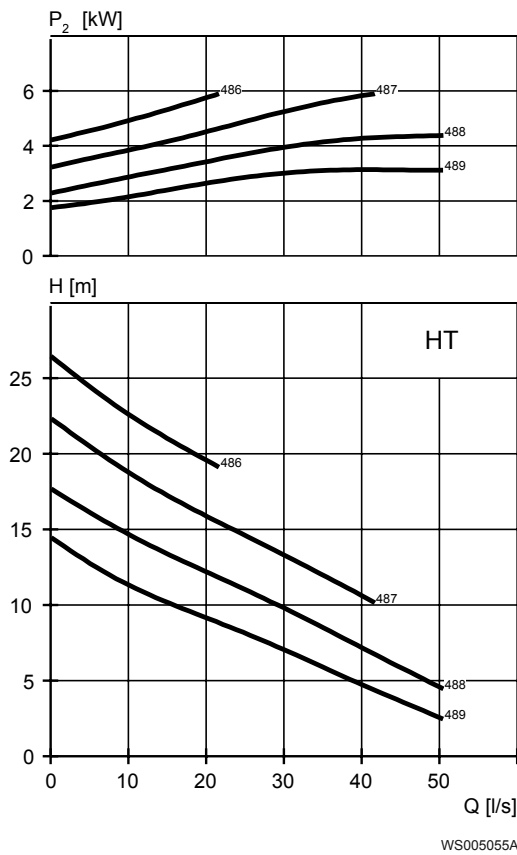
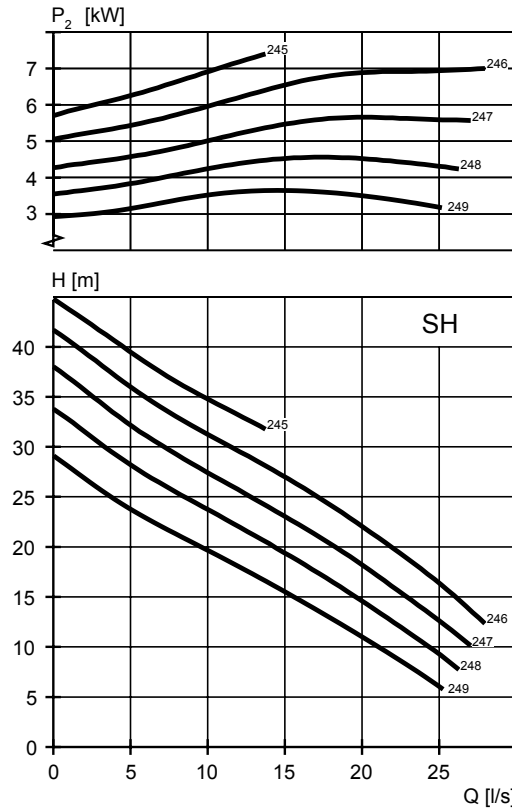

Table 27: 400 V, 50 Hz, 3-phase

Rated power, kW	Rated power, hp	Curve/ Impeller No	Revolutions per minute, rpm	Rated current, A	Starting current, A	Power factor, cos ϕ	Installation
4	5.4	489	1455	8.3	56	0.84	T,Z
4	5.4	489	1465	9.4	73	0.74	T,Z
4	5.4	489	1450	8.0	50	0.86	T,Z
4.7	6.3	488	1445	9.6	56	0.86	P,S,X

Rated power, kW	Rated power, hp	Curve/ Impeller No	Revolutions per minute, rpm	Rated current, A	Starting current, A	Power factor, cos ϕ	Installation
4.7	6.3	488	1460	10	73	0.78	P,S,X
4.7	6.3	488	1440	9.4	50	0.88	P,S,X
4.7	6.3	488	1460	11	76	0.76	T,Z
4.7	6.3	488	1465	11	91	0.74	T,Z
4.7	6.3	488	1455	9.3	62	0.87	T,Z
4.7	6.3	489	1445	9.6	56	0.86	P,S,X
4.7	6.3	489	1460	10	73	0.78	P,S,X
4.7	6.3	489	1440	9.4	50	0.88	P,S,X
4.7	6.3	489	1460	11	76	0.76	T,Z
4.7	6.3	489	1465	11	91	0.74	T,Z
4.7	6.3	489	1455	9.3	62	0.87	T,Z
5.9	7.9	486	1450	13	76	0.81	T,Z
5.9	7.9	486	1450	13	76	0.81	P,S,X
5.9	7.9	486	1460	13	91	0.79	P,S,X
5.9	7.9	486	1460	13	91	0.79	T,Z
5.9	7.9	486	1440	12	62	0.88	T,Z
5.9	7.9	486	1440	12	62	0.88	P,S,X
5.9	7.9	487	1450	13	76	0.81	T,Z
5.9	7.9	487	1450	13	76	0.81	P,S,X
5.9	7.9	487	1460	13	91	0.79	T,Z
5.9	7.9	487	1460	13	91	0.79	P,S,X
5.9	7.9	487	1440	12	62	0.88	P,S,X
5.9	7.9	487	1440	12	62	0.88	T,Z
5.9	7.9	488	1450	13	76	0.81	P,S,X
5.9	7.9	488	1460	13	91	0.79	P,S,X
5.9	7.9	488	1440	12	62	0.88	P,S,X
5.9	7.9	489	1450	13	76	0.81	P,S,X
5.9	7.9	489	1460	13	91	0.79	P,S,X
5.9	7.9	489	1440	12	62	0.88	P,S,X

SH



WS005056A

Table 28: 400 V, 50 Hz, 3-phase

Rated power, kW	Rated power, hp	Curve/ Impeller No	Revolutions per minute, rpm	Rated current, A	Starting current, A	Power factor, $\cos \varphi$	Installation
7.4	9.9	245	2885	13	100	0.92	T,Z
7.4	9.9	245	2900	14	114	0.89	T,Z
7.4	9.9	245	2900	14	114	0.89	P,S,X
7.4	9.9	245	2885	13	100	0.92	P,S,X
7.4	9.9	246	2885	13	100	0.92	T,Z
7.4	9.9	246	2900	14	114	0.89	T,Z
7.4	9.9	246	2900	14	114	0.89	P,S,X
7.4	9.9	246	2885	13	100	0.92	P,S,X
7.4	9.9	247	2885	13	100	0.92	T,Z
7.4	9.9	247	2900	14	114	0.89	T,Z
7.4	9.9	247	2900	14	114	0.89	P,S,X
7.4	9.9	247	2885	13	100	0.92	P,S,X
7.4	9.9	248	2885	13	100	0.92	T,Z
7.4	9.9	248	2900	14	114	0.89	P,S,X
7.4	9.9	248	2900	14	114	0.89	T,Z
7.4	9.9	248	2885	13	100	0.92	P,S,X
7.4	9.9	249	2885	13	100	0.92	T,Z
7.4	9.9	249	2900	14	114	0.89	T,Z
7.4	9.9	249	2900	14	114	0.89	P,S,X

Rated power, kW	Rated power, hp	Curve/ Impeller No	Revolutions per minute, rpm	Rated current, A	Starting current, A	Power factor, cos ϕ	Installation
7.4	9.9	249	2885	13	100	0.92	P,S,X

6 N-pump, Premium Efficiency Motor (IE3)

6.1 Product description



Usage

- Installation type P, S, T, Z A submersible pump for efficient pumping of clean water, surface water, and wastewater containing solids or long-fibered material. The pump is designed for sustained high efficiency. For abrasive media, Hard-Iron™ is required. Stainless steel N-impeller is available as an option.
- Installation type L A submersible pump for a mixed flow of clean water, surface water, or storm water. Intended for high flow and low head applications, in column installation. The pump is designed for sustained high efficiency.

Denomination

Table 29: Adaptive N-hydraulic

Impeller material	Non-explosion proof version	Explosion proof version	Pressure class	Installation types
Hard-Iron™	3127.920	3127.930	LT – Low head MT – Medium head HT – High head SH – Super head	L, P, S, T, Z, X
Cast iron, gray	3127.901	3127.911	LT – Low head MT – Medium head HT – High head SH – Super head	L, P, S, T, Z, X
Stainless steel	3127.961	3127.971	LT – Low head MT – Medium head HT – High head SH – Super head	L, P, S, T, Z, X

The pump can be used in the following installations:

- L Vertical semipermanent, wet well column pipe arrangement where the well is divided into a suction part and a discharge part. Pump end equipped with guide vanes.
- P Semipermanent, wet well arrangement with the pump installed on two guide bars. The connection to the discharge is automatic.
- S Portable semipermanent, wet well arrangement with hose coupling or flange for connection to the discharge pipeline.
- T Vertical permanent, dry well arrangement with flange connection to the suction and discharge piping.
- Z Horizontal permanent, dry well arrangement with flange connection to the suction and discharge piping.
- X Optional installation, wet or dry well arrangement without predetermined mechanical connection and with drilled flanges. Dry well arrangement requires cooling system or de-rated motor.

Application limits

Feature	Description
Liquid temperature	Maximum 40°C (104°F)
Depth of immersion	Maximum 20 m (65 ft)
pH of the pumped liquid	5.5 - 14
Liquid density	Maximum 1100 kg/m ³

Motor data

Feature	Description
Motor type	Line started permanent magnet motor (LSPM)
Frequency	50 Hz
Power supply	3-phase
Starting method	<ul style="list-style-type: none"> • Direct on-line • Star-delta • Soft starter • Variable Frequency Drive (VFD)
Number of starts per hour	Maximum 30
Code compliance	IEC 60034-1
Voltage variation	<ul style="list-style-type: none"> • Continuously running: Maximum $\pm 5\%$ • Intermittent running: Maximum $\pm 10\%$
Voltage imbalance between phases	Maximum 2%
Stator insulation class	H (180°C, 356°F)

Motor encapsulation

Motor encapsulation is in accordance with IP68.

Cables

Application	Type
Direct-on-line start	Flygt SUBCAB® - a heavy duty 4 cores motor power cable with two twisted pair screened control cores. Conductor insulation rating of 90°C, which allows for increased current. Superior mechanical strength and high abrasion and tear resistant. Chemical resistant within pH 3-10 and ozone, oil, and flame resistant. Used up to 70°C water temperature. Cables < 10 mm ² with unscreened control cores.

Application	Type
Y/D start	Flygt SUBCAB® - a heavy duty 7 cores motor power cable with two twisted pair screened control cores. Conductor insulation rating of 90°C, which allows for increased current. Superior mechanical strength and high abrasion and tear resistant. Chemical resistant within pH 3-10 and ozone, oil, and flame resistant. Used up to 70°C water temperature. Cables < 7G6 mm ² with unscreened control cores.
Variable Frequency drive	Screened Flygt SUBCAB® - a heavy duty 4 screened cores motor power cable with four twisted pair screened control cores. Conductor insulation rating of 90°C, which allows for increased current. Superior mechanical strength and high abrasion and tear resistant. Chemical resistant within pH 3-10 and ozone, oil, and flame resistant. Used up to 70°C water temperature.

Monitoring equipment

- Thermal contacts opening temperature 125°C (257°F)

Materials

Table 30: Major parts except mechanical seals

Denomination	Material	ASTM	EN
Major castings	Cast iron, gray	35B	GJL-250
Pump housing	Cast iron, gray	35B	GJL-250
Impeller, alternative 1	Cast iron, gray	35B	GJL-250
Impeller, alternative 2	Cast iron, Hard-Iron™	A 532 IIIA	GJN-HB555(XCR23)
Impeller, alternative 3	Stainless steel, Duplex	CD-4MCuN	10283:2010 -1.4474
Insert ring, alternative 1	Cast iron, gray	35B	GJL-250
Insert ring, alternative 2	Cast iron, Hard-Iron™	A 532 IIIA	GJN-HB555(XCR23)
Lifting handle	Stainless steel	AISI 316L	1.4404,1.4432, ...
Shaft	Stainless steel	AISI 431	1.4057+QT800
Screws and nuts	Stainless steel, A4	AISI 316L, 316, 316Ti	1.4401,1.4404, ...
O-rings, alternative 1	Nitrile rubber (NBR) 70° IRH	-	-
O-rings, alternative 2	Fluorinated rubber (FPM) 70° IRH	-	-
Oil, part no 901752	Medical white oil of paraffin type. Fulfills FDA 172.878 (a)	-	-

Table 31: Mechanical seals

Alternative	Inner seal	Outer seal
1	Corrosion resistant cemented carbide (WCCR)/ Aluminum oxide (Al ₂ O ₃)	Corrosion resistant cemented carbide (WCCR)/ Corrosion resistant cemented carbide (WCCR)
2	Corrosion resistant cemented carbide (WCCR)/ Corrosion resistant cemented carbide (WCCR)	Silicon carbide (RSiC)/ Silicon carbide (RSiC)
3	Corrosion resistant cemented carbide (WCCR)/ Corrosion resistant cemented carbide (WCCR)	Corrosion resistant cemented carbide (WCCR)/ Corrosion resistant cemented carbide (WCCR)

Surface treatment

All cast parts are primed with a water-borne primer. The finishing coat is a high-solid two pack paint.

Priming	Finish
Painted with a primer, see internal standard M0700.00.0002	Navy gray color NCS 5804-B07G. Two-component high-solid top coating, see internal standard M0700.00.0004 for standard painting and M0700.00.0008 for special painting.

Options

- Leakage sensor in the stator housing (FLS)
- Leakage sensor in the oil housing (CLS)
- Surface treatment (Epoxy)
- Zinc anodes
- Other cables

Accessories

Discharge connections, adapters, hose connections, and other mechanical accessories
 Electrical accessories such as pump controller, control panels, starters, monitoring relays, cables

6.2 Motor rating and performance curves

These are examples of motor rating and curves. For more information, please contact your local sales and service representative.

Star-delta starting current is 1/3 of Direct on-line starting current.

LT

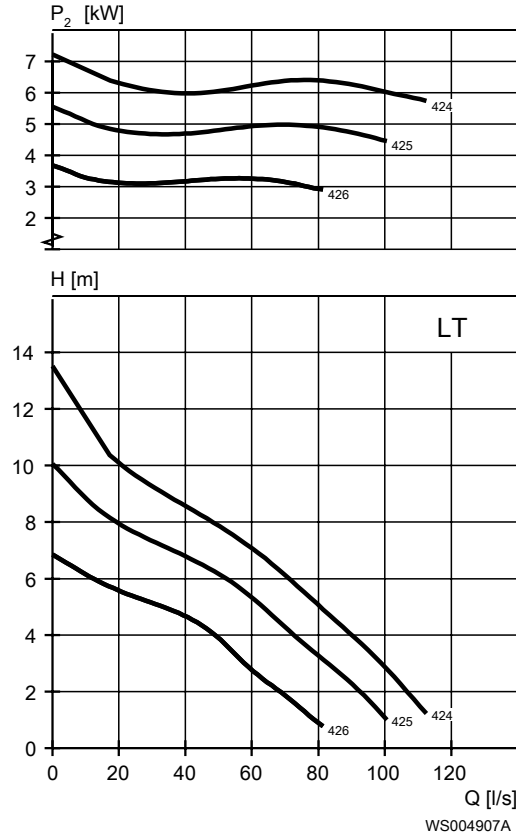

Table 32: 400 V, 50 Hz, 3-phase

Rated power, kW	Rated power, hp	Curve/ Impeller No	Revolutions per minute, rpm	Rated current, A	Starting current, A	Power factor, cos ϕ	Installation
5	6.7	425	1500	8.9	76	0.89	P,S,X
5	6.7	426	1500	8.9	76	0.89	L
5	6.7	426	1500	8.9	76	0.89	P,S,X
5.5	7.4	424	1500	9.6	76	0.9	T,Z
5.5	7.4	425	1500	9.6	76	0.9	T,Z
5.5	7.4	426	1500	9.6	76	0.9	T,Z
6.5	8.7	424	1500	11	76	0.91	L
6.5	8.7	424	1500	11	76	0.91	P,S,X
6.5	8.7	424	1500	11	76	0.91	T,Z
6.5	8.7	425	1500	11	76	0.91	L
6.5	8.7	425	1500	11	76	0.91	P,S,X
6.5	8.7	426	1500	11	76	0.91	L
6.5	8.7	426	1500	11	76	0.91	P,S,X

MT

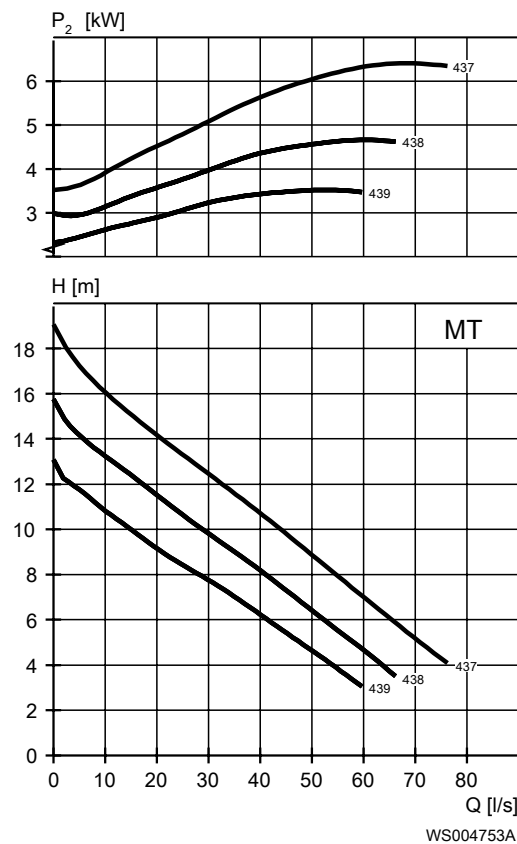

Table 33: 400 V, 50 Hz, 3-phase

Rated power, kW	Rated power, hp	Curve/ Impeller No	Revolutions per minute, rpm	Rated current, A	Starting current, A	Power factor, cos ϕ	Installation
5	6.7	438	1500	8.9	76	0.89	P,S,X
5	6.7	439	1500	8.9	76	0.89	P,S,X

Rated power, kW	Rated power, hp	Curve/ Impeller No	Revolutions per minute, rpm	Rated current, A	Starting current, A	Power factor, cos φ	Installation
5.5	7.4	438	1500	9.6	76	0.9	T,Z
5.5	7.4	439	1500	9.6	76	0.9	T,Z
6.5	8.7	437	1500	11	76	0.91	T,Z
6.5	8.7	437	1500	11	76	0.91	P,S,X
6.5	8.7	438	1500	11	76	0.91	P,S,X
6.5	8.7	439	1500	11	76	0.91	P,S,X

HT

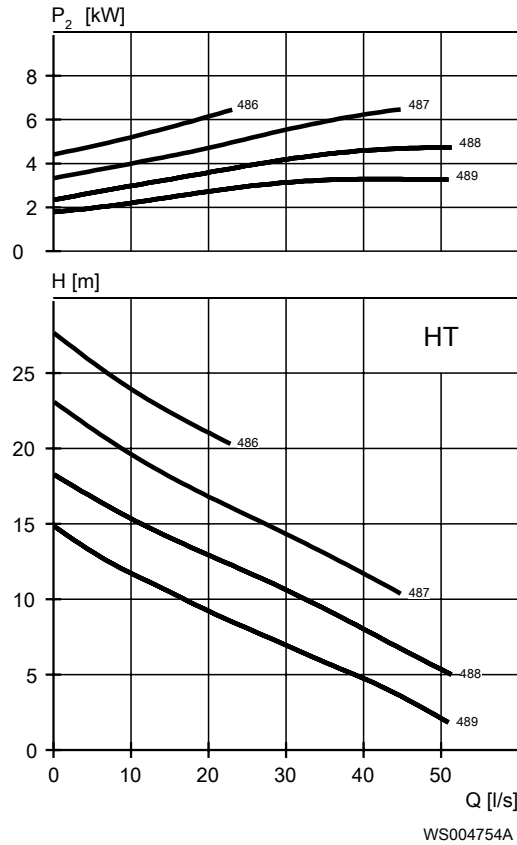

Table 34: 400 V, 50 Hz, 3-phase

Rated power, kW	Rated power, hp	Curve/ Impeller No	Revolutions per minute, rpm	Rated current, A	Starting current, A	Power factor, cos φ	Installation
5	6.7	488	1500	8.9	76	0.89	P,S,X
5	6.7	489	1500	8.9	76	0.89	P,S,X
5.5	7.4	488	1500	9.6	76	0.9	T,Z
5.5	7.4	489	1500	9.6	76	0.9	T,Z
6.5	8.7	486	1500	11	76	0.91	P,S,X
6.5	8.7	486	1500	11	76	0.91	T,Z
6.5	8.7	487	1500	11	76	0.91	P,S,X
6.5	8.7	487	1500	11	76	0.91	T,Z
6.5	8.7	488	1500	11	76	0.91	P,S,X
6.5	8.7	489	1500	11	76	0.91	P,S,X

SH

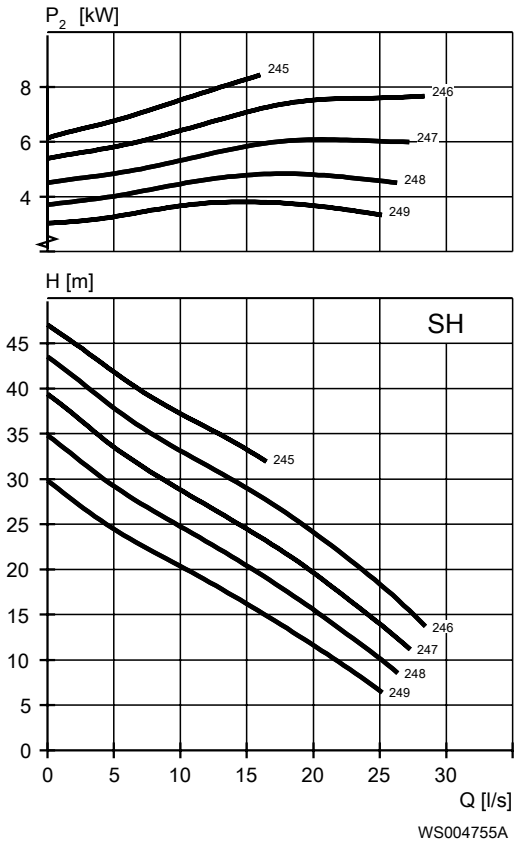

Table 35: 400 V, 50 Hz, 3-phase
IE3 compliance is based on Y-connected stator.

Rated power, kW	Rated power, hp	Curve/ Impeller No	Revolutions per minute, rpm	Rated current, A	Starting current, A	Power factor, cos φ	Installation
8.5	11.4	245	3000	16	126	0.84	P,S,X
8.5	11.4	245	3000	16	126	0.84	T,Z
8.5	11.4	246	3000	16	126	0.84	P,S,X
8.5	11.4	246	3000	16	126	0.84	T,Z
8.5	11.4	247	3000	16	126	0.84	T,Z
8.5	11.4	247	3000	16	126	0.84	P,S,X
8.5	11.4	248	3000	16	126	0.84	T,Z
8.5	11.4	248	3000	16	126	0.84	P,S,X
8.5	11.4	249	3000	16	126	0.84	P,S,X
8.5	11.4	249	3000	16	126	0.84	T,Z

7 Dimensions and Weight

7.1 Drawings

These drawings are included as examples.

All drawings are available as Acrobat documents (.pdf) and AutoCad drawings (.dwg).
Contact a local sales and service representative for more information.

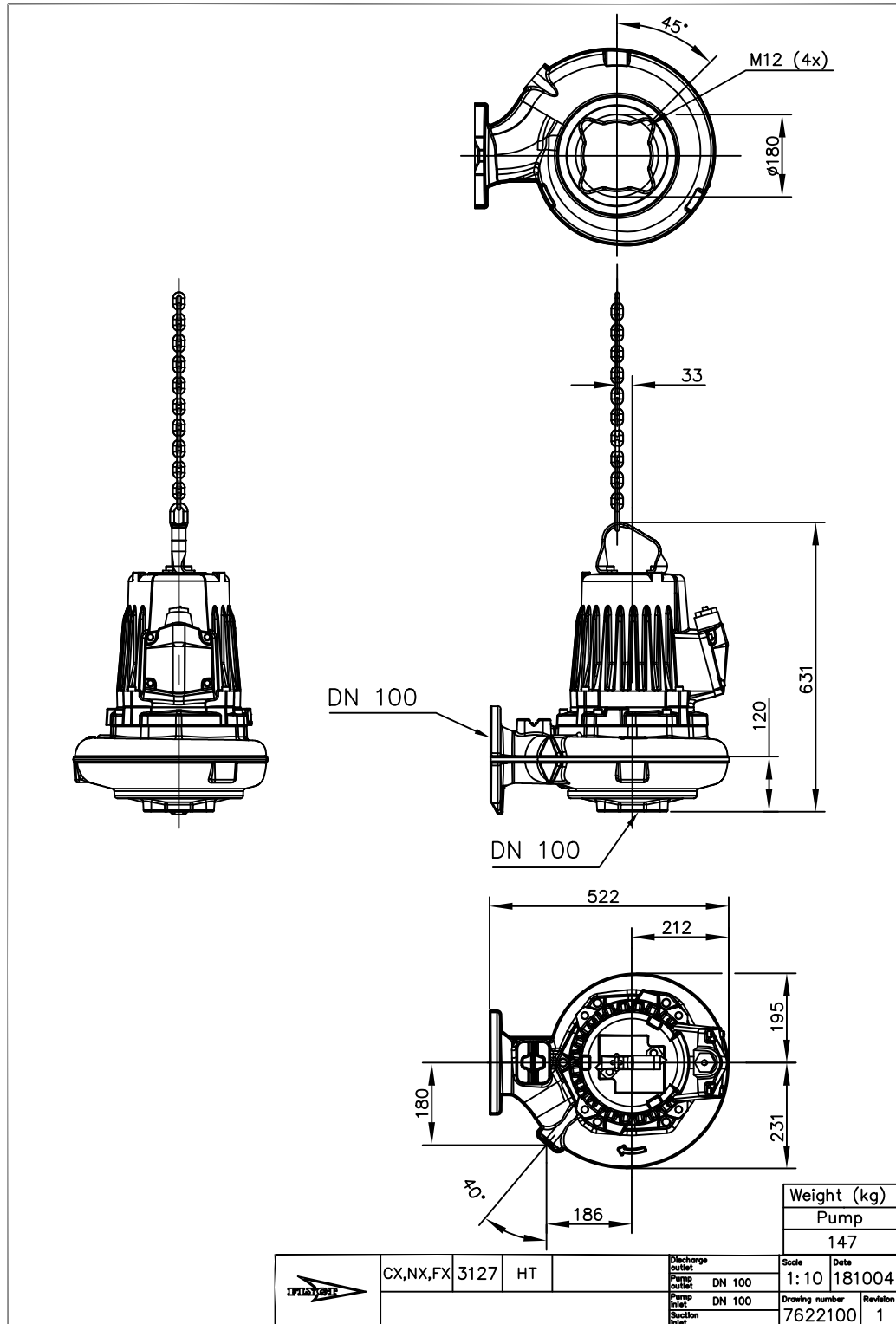

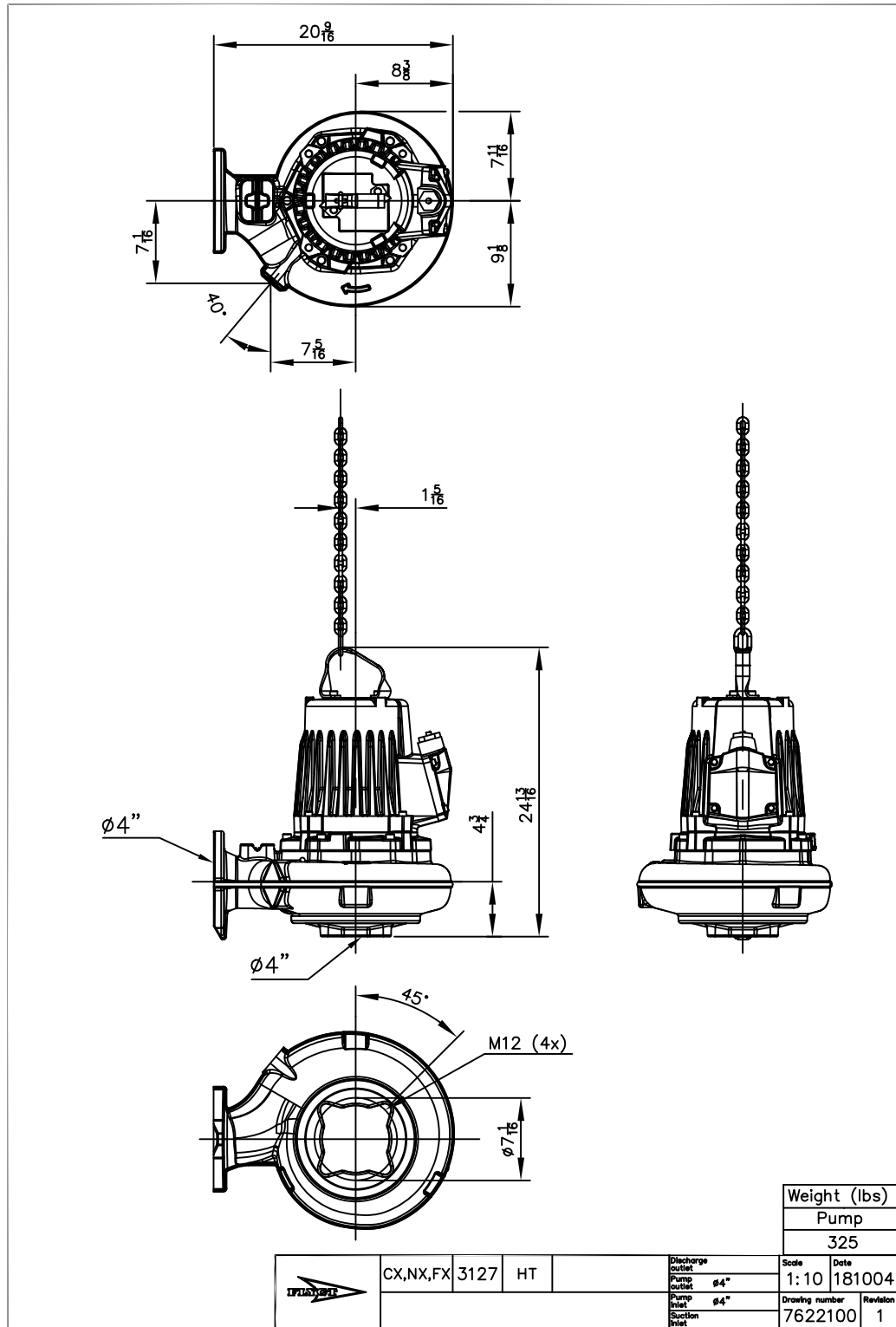

Xylem |'zīləm|

- 1) The tissue in plants that brings water upward from the roots;
- 2) a leading global water technology company.

We're a global team unified in a common purpose: creating advanced technology solutions to the world's water challenges. Developing new technologies that will improve the way water is used, conserved, and re-used in the future is central to our work. Our products and services move, treat, analyze, monitor and return water to the environment, in public utility, industrial, residential and commercial building services settings. Xylem also provides a leading portfolio of smart metering, network technologies and advanced analytics solutions for water, electric and gas utilities. In more than 150 countries, we have strong, long-standing relationships with customers who know us for our powerful combination of leading product brands and applications expertise with a strong focus on developing comprehensive, sustainable solutions.

For more information on how Xylem can help you, go to www.xylem.com



Xylem Water Solutions Global
Services AB
361 80 Emmaboda
Sweden
Tel: +46-471-24 70 00
Fax: +46-471-24 74 01
<http://tpi.xylem.com>
[www.xylemwatersolutions.com/
contacts/](http://www.xylemwatersolutions.com/contacts/)

Visit our Web site for the latest version of this document and more information

The original instruction is in English. All non-English instructions are translations of the original instruction.

© 2020 Xylem Inc